

**OMEGA-PHONE™**

***DCKT970 DIGITAL  
WIRELESS  
KEY TELEPHONE***

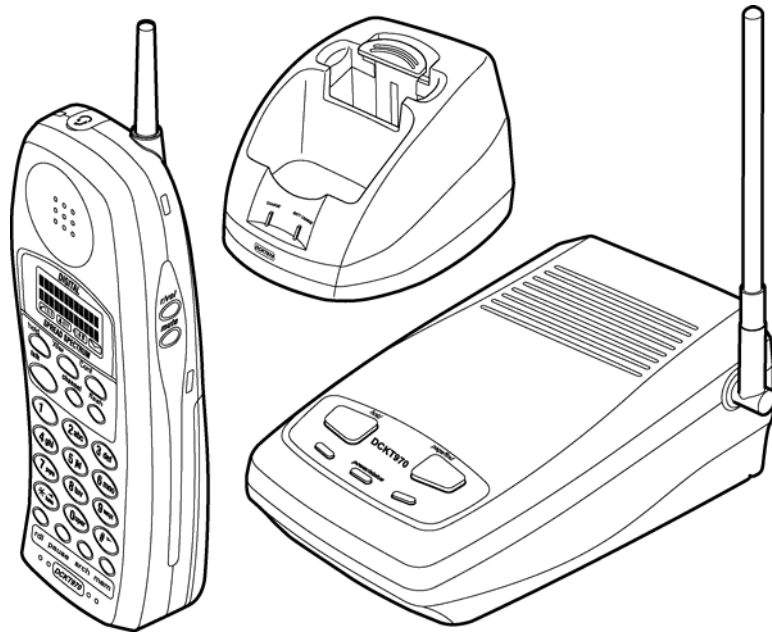

***OWNER'S MANUAL***

**IWATSU**

## **SPECIAL NOTICE**

### **TOLL RESTRICTION**

The Toll Restriction feature of the ADIX APS system is one method of preventing fraud (i.e., the making of unauthorized toll calls) by users of the system. The chance of fraud may be reduced but may not be eliminated. Therefore, no expressed or implied warranty is made against fraud. Only a complete program which includes but may not be limited to inspection of telephone call billing, use of call detail recorders and other such devices, systematic monitoring of all telephone call activity, and implementing corrective measures can minimize the possibility of fraud. Consult with your Authorized Iwatsu America Distributor for further details or assistance in the event you are experiencing unauthorized toll calls.

### **DISA**

The Direct Inward System Access (DISA) feature, with the ability to allow outside parties to connect to the internal services of ADIX, may provide a means for fraudulent calls to occur. Therefore, no expressed or implied warranty is made against fraud. Only a complete program which includes but may not be limited to inspection of telephone call billing, use of call detail recorders and other such devices, systematic monitoring of all telephone call activity, frequently changing DISA authorization codes, and implementing corrective measures can minimize the possibility of fraud. Consult with your Authorized Iwatsu America Distributor for further details or assistance in the event you are experiencing unauthorized toll calls.

All brand names and product names used in this manual are trademarks of their respective companies.

Iwatsu America, Inc., 8001 Jetstar Drive, Irving, TX 75063,  
(972) 929-0242

© 2009 by Iwatsu America, Inc.

All rights reserved.

**Second Edition March 2009**

Printed in the United States of America

All rights are reserved. No part of this manual or accompanying software may be reproduced, in any form or any means, without the permission of Iwatsu America, Inc.

This manual was written for systems with ADIX Software Version 7.20 and higher. In some cases, available feature operations may differ from those listed in this manual, depending on the hardware, software and programmed functions in your ADIX system. For more information contact your authorized Iwatsu distributor.

Iwatsu America, Inc. has used its best effort to ensure that the information in this manual was accurate at the time of printing. Iwatsu America, Inc. makes no warranty of any kind, expressed or implied, with regard to the contents of this manual. This information is subject to change without notice.

Iwatsu America, Inc. shall not be held responsible for any representation made regarding this information by any individual.

For warranty information, contact your Authorized Iwatsu Distributor.

**Part Number: 109530**

# Precautions

**Before you read anything else,  
please observe the following:**

## **WARNING!**

Iwatsu America Inc. **DOES NOT** represent this unit to be waterproof. To reduce the risk of fire, electrical shock or damage to the unit, **DO NOT** expose this unit to rain or moisture.

## **BATTERY WARNING**

This equipment contains a Rechargeable Nickel-Cadmium Battery.

**Do not** short circuit the battery.

**Do not** charge the Rechargeable Nickel-Cadmium Battery used in this equipment in any charger other than the one designed to charge this battery as specified in this Guide. Using another charger may damage the battery or cause the battery to explode.

**Do not** remove or damage the battery casing.

**Never throw the battery into a fire, disassemble it or heat it.**





# Contents

<b>Safety Instructions</b> .....	<b>1</b>
Rechargeable Nickel-Cadmium Battery Warning .....	3
<b>Introduction</b> .....	<b>5</b>
Handset Controls & Functions .....	5
Base Unit Controls & Functions.....	7
About Your DCKT970.....	8
Important Electrical Considerations .....	10
<b>Installing Your DCKT970</b> .....	<b>13</b>
Selecting the Installation Location .....	13
Connecting the Telephone Cords.....	14
Using an ADIX Digital Key Telephone with the DCKT970.....	15
Supplying Power to the Base Unit.....	16
Wall Installation .....	18
Attaching the Belt Clip to the Handset .....	24
Installing the Handset Battery Pack.....	25
Charging the Handset Battery Pack .....	26
Charging Spare Battery Packs .....	27
Low Battery Indicator.....	28
Cleaning the Battery and Charging Unit Contacts.....	28
<b>Using Your DCKT970 Handset</b> .....	<b>29</b>
DCKT970 Handset Controls .....	30
Using the Handset .....	32
Answering a Call .....	33
Making a Call.....	33
Switching the Call on the Desk Telephone to the DCKT970 .....	34
Switching a Call from the DCKT970 to the Desk Telephone.....	34
Making a Call .....	35
<b>Feature Operation</b> .....	<b>37</b>
Placing a Call “On Hold” .....	37
Transferring a Call.....	37
Feature Access Codes.....	38
<b>Optional (EXP9530) Headset</b> .....	<b>39</b>
EXP9530 Headset.....	39
<b>Optional Accessories and Replacement Parts</b> .....	<b>41</b>
<b>Troubleshooting</b> .....	<b>43</b>
<b>Specifications</b> .....	<b>45</b>



# Safety Instructions

When using your DCKT970 Digital Wireless Key Telephone, follow the instructions listed below to reduce the risk of fire, electrical shock and injury to persons.

1. Read and understand all instructions.
2. Follow all warnings and instructions marked on the product.
3. Unplug this product from the wall outlet before cleaning. Do not use liquid cleaners or aerosol cleaners. Use a dry cloth for cleaning.
4. **Do not** use this product near water; for example, near a sink or in a wet area.
5. **Do not** place this product on an unstable cart, stand or table. The telephone may fall, causing serious damage to the unit.
6. To protect the product from overheating, do not block or cover any slots or openings in the base unit. This product should never be placed near or over a radiator or heat register. This product should not be placed in an enclosed space unless proper ventilation is provided.
7. This product should be operated using only the type of power source indicated on the marking label.
8. **Do not** allow anything to rest on the power cord. Do not place this product where the cord may be damaged by persons walking on it.
9. **Do not** overload wall outlets and extension cords, as this can result in the risk of fire or electrical shock.

10. Never put objects of any kind into this product through the Base Unit slots, as they may touch dangerous voltage points or short out parts that could result in a risk of fire or electric shock. Never spill liquid of any kind on the product.
11. To reduce the risk of electric shock, do not disassemble this product. Contact your Authorized Iwatsu Distributor when service or repair work is required. Opening or removing covers may expose you to dangerous voltages or other risks. Incorrect reassembly can cause electric shock when the appliance is subsequently used.
12. Unplug this product from the wall outlet and refer servicing to Authorized Iwatsu Distributor under the following conditions:
  - A. When the power supply cord is damaged or frayed.
  - B. If liquid has been spilled on the product.
  - C. If the product has been exposed to rain or water.
  - D. If the product does not operate normally when following the operating instructions. Adjust only those controls that are covered by the operating instructions. Improper adjustment of other controls may result in damage, and will often require extensive work by a qualified technician to restore the product to normal operation.
  - E. If the product has been dropped or the cabinet has been damaged.
  - F. If the product exhibits a distinct change in performance.
13. Do not use the telephone to report a gas leak in the vicinity of the leak.

## Rechargeable Nickel-Cadmium Battery Warning

---

This equipment contains a rechargeable Nickel-Cadmium battery. The RBRC™ seal on the nickel-cadmium battery indicates that Iwatsu is voluntarily participating in an industry program to collect and recycle these batteries at the end of their useful lives when taken out of service in the United States. Instead of placing nickel-cadmium batteries into the trash or a municipal waste site, which is illegal in some areas, Iwatsu's participation in the RBRC™ program allows you to recycle the spent battery by dropping it off at local retailers of replacement nickel-cadmium batteries or at the authorized Iwatsu distributor from whom you purchased the product. For more information on recycling spent nickel-cadmium batteries contact your local recycling center or call 1-800-8-BATTERY.



**CAUTION!** To avoid the risk of fire and injury to persons by the battery, follow the precautions listed below.

- Use only the appropriate type and size battery pack specified in this manual.
- Do not dispose of the battery pack in a fire; the cell may explode.
- Do not open or mutilate the battery pack. Released electrolyte is corrosive and may cause injury when it comes in contact with the eyes or skin. Electrolyte is toxic if swallowed.
- Do not short-circuit the battery. Short-circuit is possible when the battery pack comes in contact with conducting materials such as rings keys and bracelets.
- Charge the battery pack only in accordance with the instructions and limitations specified in this manual.

- Observe proper polarity orientation between the battery pack and battery charger.

**CAUTION!** To reduce the risk of fire or injury to persons by the battery, read and follow these instructions:

1. Use only the appropriate type and size Battery Pack specified in this Operating Guide.
2. Do not dispose of the Battery Pack in a fire. The cell may explode.
3. Do not open or mutilate the Battery Pack. Released electrolyte is corrosive and may cause damage to the eyes or skin. It may be toxic if swallowed.
4. Exercise care in handling the battery in order not to short the battery with conducting materials such as rings, bracelets, and keys. The battery or conductor may overheat and cause burns.
5. Charge the Battery Pack provided with or identified for use with this product only in accordance with the instructions and limitations specified in the instruction manual provided for this product.
6. Observe proper polarity orientation between the Battery Pack and battery charger.

# Introduction

Congratulations on your purchase of the DCKT970 Digital Wireless Key Telephone. The DCKT970 Digital Wireless Key Telephone is designed and engineered to exacting standards for reliability, long life and outstanding performance. It is designed to work with the Iwatsu ADIX APS and ADIX-VS systems. To get the most from your DCKT970, please read this Owner's Manual thoroughly.

## Handset Controls & Functions

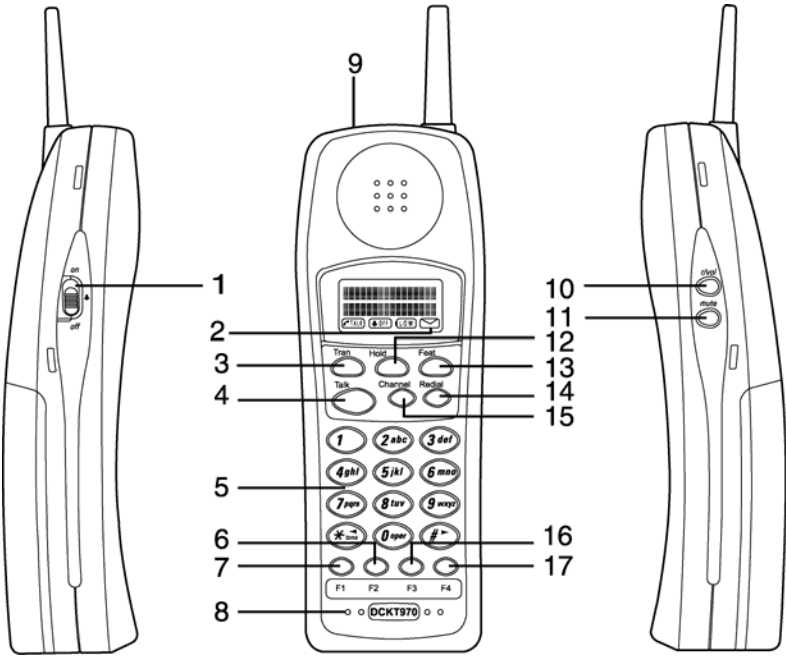

1. Ringer ON/OFF switch
2. Message Display
3. Transfer (*Tran*) Key
4. Talk (*Talk*) Key
5. Numeric Keypad
6. Flexible (*F2*) Key
7. Flexible (*F1*) Key
8. Microphone
9. Headset Jack
10. Volume (*R/Vol*) Key
11. Mute (*Mute*) Key
12. Hold (*Hold*) Key
13. Feature (*Feat*) Key
14. Redial (*Redial*) Key
15. Channel Key
16. Flexible (*F3*) Key
17. Flexible (*F4*) Key

## Base Unit Controls & Functions

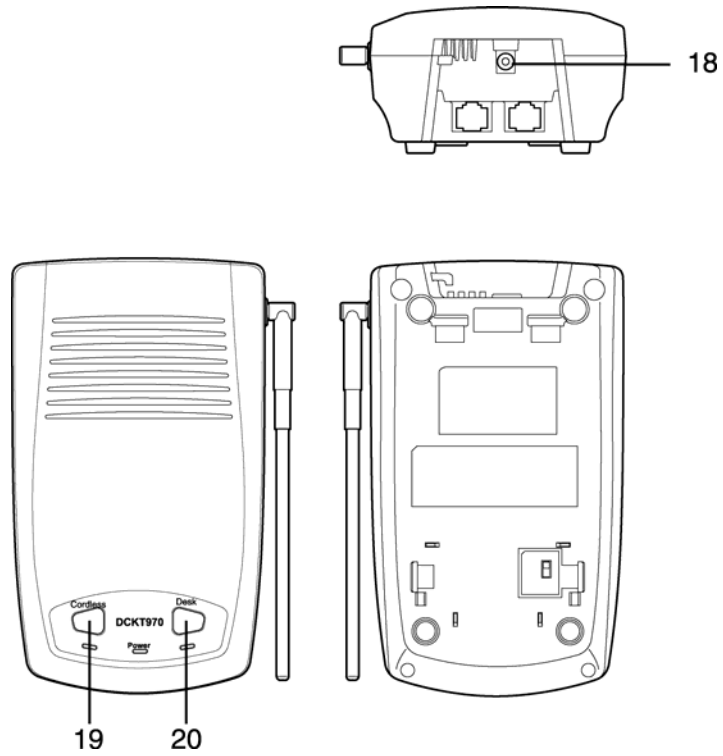

- 18. DC Power Jack
- 19. Cordless Key
- 20. Desk Key

## About Your DCKT970

---

### DCKT Components

Your DCKT970 Digital Wireless Key Telephone includes the following items:



Base Unit



Handset



Telephone Cord

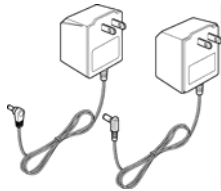

2 AC Adaptors

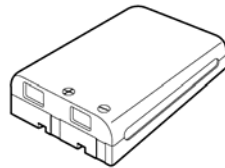

Rechargeable Battery



Belt Clip

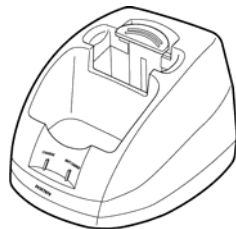

Charging Stand



Owner's Manual

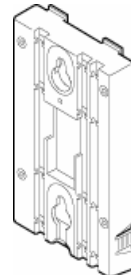

Wall Plate Adaptor

If any of these items are missing or damaged, contact your telephone administrator. If your DCKT970 is not performing to your expectations, please try the simple steps listed in the

Troubleshooting Section of this Guide. If you are still unable to resolve the problem, contact your telephone administrator

### **DCKT970 Features**

Super Long Range 900MHz Digital Spread Spectrum

2-line, 16-digit LCD Display

Headset Jack

Ringer Volume Control

Handset Volume Control

Four Programmable Keys

Separate Charging Stand with Spare Battery Charging Capability

AutoStandby

AutoTalk

Vibrate Ringer Alert

Easy Installation

Out of Range Protection

Low Battery Protection System (6-hour talk time, 4-day standby time)

Wall Mountable separate Base Unit

Wall Mountable separate Charging Unit

Headset Jack (2.5mm)

## **Important Electrical Considerations**

---

**Warning!**            **Please do not attempt to unplug any appliance during an electrical storm.**

Unplug all electrical appliances when you know an electrical storm is approaching. Lightning can pass through your household wiring and damage any device connected to it. This phone is no exception.

**Caution!**            **Changes or modifications to this product not expressly approved by Iwatsu or operation of this product in any way other than as detailed by this Owner's Manual could void your authority to operate this product.**

### **Range**

Your new phone is designed to achieve the maximum possible range by transmitting and receiving according to the highest specifications set forth by the FCC and IC. We have rated this phone to operate at a maximum distance with the qualification that the range depends upon the environment in which the telephone is used. Many factors limit range, and it would be impossible to include all the variables in our rating. Use the Maximum Range rating of this phone as a means of comparison against other range claims.

### **Telephone Line Problems**

The FCC and IC have granted the telephone company the right to disconnect service in the event that your phone causes problems on the telephone line. Also, the telephone company may make changes in facilities and services, which may affect the operation of your unit. However, your telephone company must give adequate notice in writing prior to such actions to allow you time for making necessary arrangements to continue uninterrupted service.

If you are having trouble with your telephone service, you must first disconnect your phone to determine if it is the cause of your problem. If you determine that it is the cause,

you must leave it disconnected until the trouble has been corrected.

### **Radio Interference**

Radio interference may occasionally cause buzzing and humming in your DCKT970 Digital Wireless Key Telephone, or clicking noises in the Base Unit. This interference is caused by external sources such as a TV, refrigerator, vacuum cleaner, fluorescent lighting, computer equipment or an electrical storm. Your unit is NOT DEFECTIVE. If these noises continue and are too distracting, please check around your office to see what appliances may be causing the problem. In addition, we recommend that the Base Unit not be plugged into a circuit that also powers a major appliance because of the potential for interference. Be certain that the antenna on the Base Unit is fully extended when needed.

In the unlikely event that you consistently hear other voices or distracting transmissions on your phone, you may be receiving radio signals from another cordless telephone or another source of interference. If you cannot eliminate this type of interference, you need to change to a different channel.

Finally, it should be noted that some cordless telephones operate at frequencies that may cause interference to nearby TVs and VCRs. To minimize or prevent such interference, the base of the cordless telephone should not be placed near or on top of a TV or VCR. If interference is experienced, moving the cordless telephone farther away from the TV or VCR will often reduce or eliminate the interference.

### **More Than One DCKT970**

If you want to use more than one DCKT970 Digital Wireless Key Telephone in your office, they must operate on different channels. Press the channel key to select a channel that provides the clearest communication.

## **Privacy**

***Note:** DCKT970 Digital Wireless Key Telephone is a radio device. Communications between the Handset and Base Unit of your DCKT970 are accomplished by means of radio waves that broadcast over the open airways. Because of the inherent physical properties of radio waves, your communications can be received by radio receiving devices other than your own DCKT970. Consequently, any communications using your DCKT970 may not be private.*

## **Installing Your DCKT970**

### **Selecting the Installation Location**

Select a location for the DCKT970 Digital Wireless Key Telephone that avoids excessive heat or humidity. The Base Unit of your DCKT970 may be placed on a desk or tabletop near a standard 120V AC outlet and telephone line jack. The Base Unit can also be mounted on a standard AT&T or GTE wall plate using the optional Wall Mount Adapter. If you will use the DCKT970 with an IX-12KTD / S-3 Digital Key Telephone, place the DCKT970 near that phone. Keep the Base Unit and Handset away from sources of electrical noise (motors, fluorescent lighting, and computers).

## Connecting the Telephone Cords

---

The DCKT970 Digital Wireless Key Telephone must be connected to an ADIX Digital Station port (IX-8PSUB-1, IX-16PSUB, IX-408 or an IX-044).

### CAUTION!

- Never install telephone wiring during a lightning storm.
- Never touch non-insulated telephone wires or terminals unless the telephone line has been disconnected at the network interface.
- Use caution when installing or modifying telephone lines.

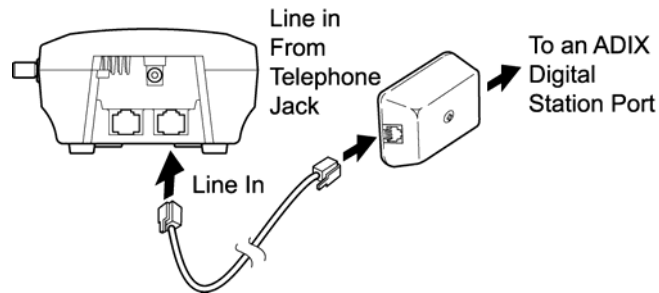

## Using an ADIX Digital Key Telephone with the DCKT970

### ADIX Digital Telephone

An ADIX Digital Key telephone can be used with the DCKT970 Digital Wireless Key Telephone. Calls can then be answered with the Desk phone and transferred to the DCKT970.

*Note:* A special Security Feature disconnects the Desk phone whenever the DCKT970 Handset is in use.

### Connecting the Desk Telephone

Connect a telephone cord from the Desk phone to the LINE OUT jack on the DCKT970 Base Unit.

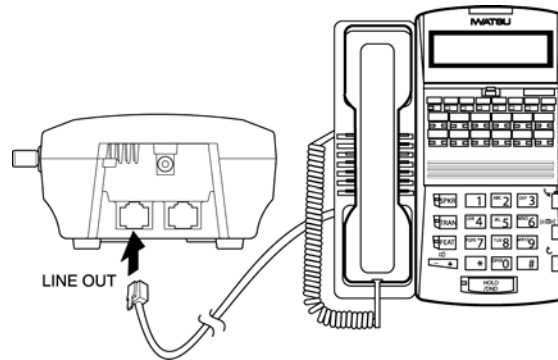

The Desk phone can now be used to answer or place calls in the normal manner.

## Supplying Power to the Base Unit

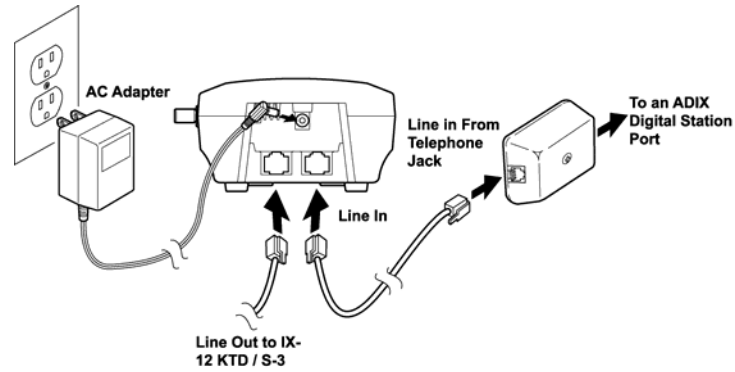

Use only the supplied AC Adapter: EXP9704

**IMPORTANT!** Place the power cord so that it does not create a trip hazard, or where it could become chafed and create a fire or other electrical hazards.

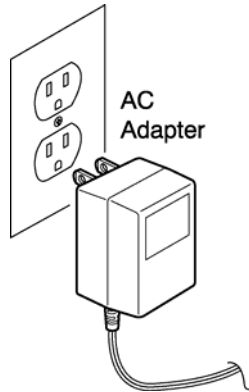

**Note:** *The AC adaptor supplied with the DCKT970 Digital Wireless Key Telephone is equipped with a polarized line plug (one blade wider than the other). This plug will fit into the power outlet in only one way. If you are unable to insert the plug fully into the outlet, try reversing the plug. If you still cannot plug the AC adaptor into the outlet, contact your Authorized Iwatsu Distributor.*

The unique design of your DCKT970 Digital Wireless Key Telephone allows you to place the Handset in the Charging Unit with or without the Belt Clip attached. The Charging Unit also has the ability to charge a second battery with or without the Handset being charged. The Battery Packs can automatically be recharged either in or out of the Handset.

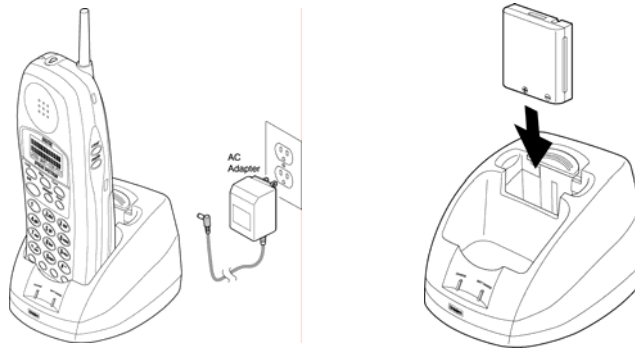

Use only the supplied AC Adapter: AD-970

## Wall Installation

---

### Standard Wall Plate Mounting

The DCKT970 Digital Wireless Key Telephone is designed to mount on a standard AT&T or GTE wall plate. To attach the wall mount stand to the Base Unit:

1. Slide the Wall Mount stand into the notches at the top of the Base Unit, push the Wall Mount stand down and snap it into place.

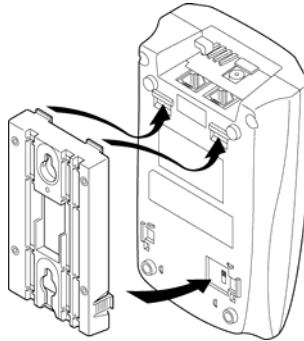

2. Plug the AC Adapter into the Base Unit as previously described.
3. Place the AC Adapter cord inside the molded channel of the Wall Mount stand.

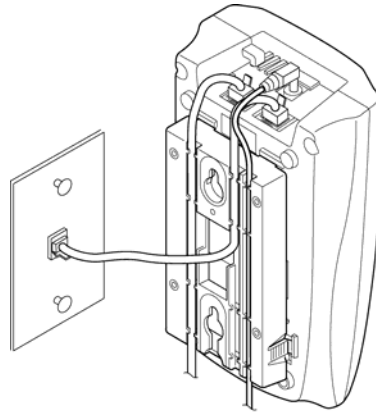

4. Plug one end of the short telephone cord into the **LINE IN** jack on the Base Unit. Optionally, plug one end of an IX-12KTD / S-3 Digital Key Telephone into the **LINE OUT** jack. Then place the telephone cord(s) inside the molded channel(s) on the bottom of the Wall Mount stand.
5. Plug the other end of the short telephone cord into the modular wall jack.
6. Place the Base Unit on the posts of the wall plate and push down until it's firmly seated.

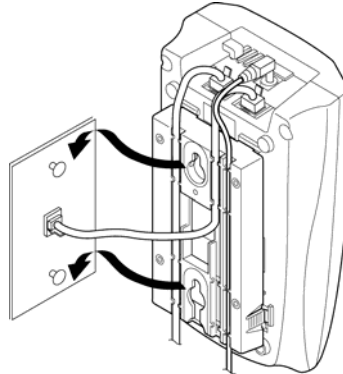

7. Plug the AC Adapter into a standard 120V AC wall outlet.

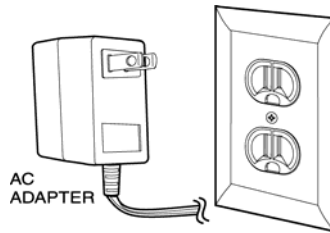

*Note: Do not use an outlet controlled by a wall switch.*

### Direct Wall Mounting

If you do not have a standard wall plate, you can mount the DCKT970 Digital Wireless Key Telephone directly on a wall. Before mounting the DCKT970, consider the following:

- Select a location away from electrical cables, pipes, or other items behind the mounting location that could cause a hazard when inserting screws into the wall.
  - Make sure the wall material is capable of supporting the weight of the Base Unit.
  - Use #10 screws with anchoring devices suitable for the wall material where the Base Unit will be placed.
1. Insert two mounting screws into the wall 3-15/16 inches apart. Allow about 3/16 of an inch between the wall and screw heads for mounting the phone.

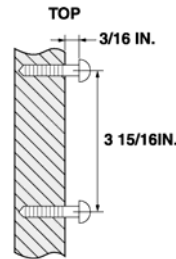

2. Plug and secure the AC Adapter cord by following steps 2 and 3 of the **Standard Wall Plate Mounting Section**.
3. Plug one end of the telephone line cord into the **LINE IN** jack on the Base Unit. Optionally, plug one end of an IX-12KTD / S-3 Digital Key Telephone into the **LINE OUT** jack. Then place the telephone cord(s) inside the molded channel(s) on the bottom of the Wall Mount stand.

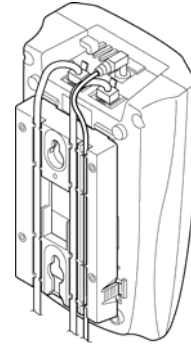

4. Place the Base Unit on the posts of the wall screws and push down until it is firmly seated.

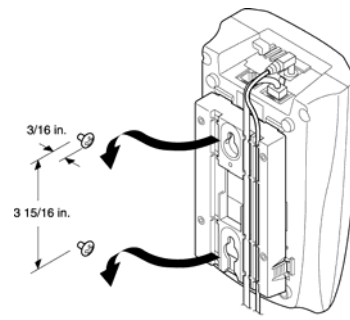

5. Plug the other end of the short telephone cord into a telephone wall jack.

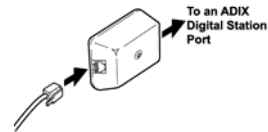

6. Plug the AC Adapter into a standard 120V AC wall outlet by following step 7 of the **Standard Wall Plate Mounting**.

## Charging Unit Wall Mounting

The Charging Unit is also designed to be wall mounted.

Before mounting your charging unit, consider the following:

- Select a location away from electrical cables, pipes, or other items behind the mounting location that could cause a hazard when inserting screws into the wall.
- Make sure the wall material is capable of supporting the weight of the Charging Unit.
- Use #10 screws with anchoring devices suitable for the wall material where the Charging Unit will be placed.

1. Insert two mounting screws into the wall 1-9/10 inches apart. Allow about 3/16 of an inch between the wall and screw heads for mounting the phone.

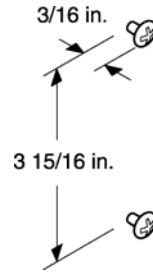

2. Plug the AC Adapter into the Charging Unit as previously described. Wrap the AC Adapter cord around the strain relief.

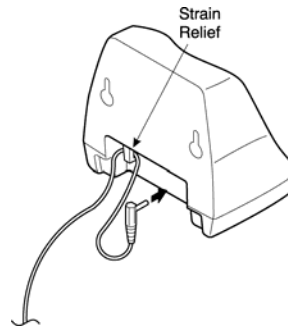

3. Place the Charging Unit on the posts of the wall screws and push down until it is firmly seated.

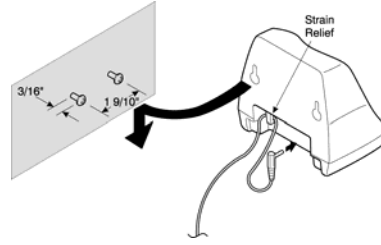

4. Plug the AC Adapter into a standard 120V AC wall outlet.

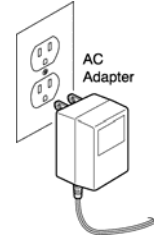

## Attaching the Belt Clip to the Handset

---

You can use the Belt Clip to attach the Handset to your belt or pocket for convenient portability.

1. Slide the clip into the tab slot. (**Note:** The Belt Clip is designed to fit snugly onto the Handset.)

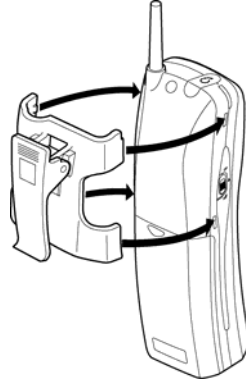

2. Press firmly until it snaps into place.

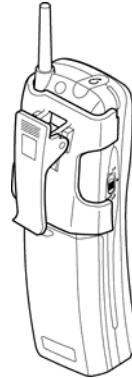

3. To remove, simply press the retaining clip in toward the Belt Clip blade and slide the clip up at the same time.

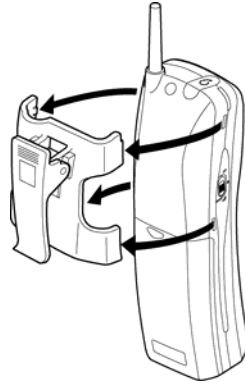

## **Installing the Handset Battery Pack**

1. Remove the battery cover by pressing the latch and sliding the cover down until it comes off the Handset.

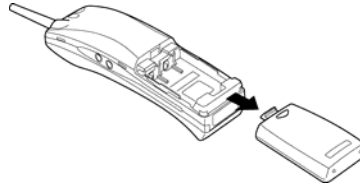

2. Slide the Battery Pack down into the Handset.

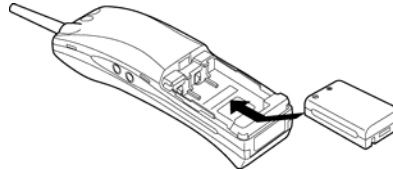

*Note:* You may have to remove the old battery at this time.

3. Securely close the battery compartment cover by sliding it up until it snaps into place.

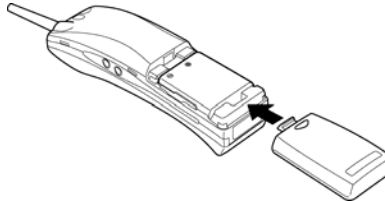

## **Charging the Handset Battery Pack**

---

The Rechargeable Nickel-Cadmium Battery Pack must be fully charged before using your DCKT970 for the first time.

**Note:** *Charge the Battery Pack without interruption for 12 to 15 hours.*

1. Place the Handset in the front slot of the Charging Unit.
2. Make sure the CHARGE indicator lights. If the CHARGE light does not light, check to see that the AC Adapter is plugged-in, and that the Handset makes good contact with the Charging Unit charging contacts.



## Charging Spare Battery Packs

---

The Charger Unit of your DCKT970 is designed to charge the Spare Battery Pack with or without the Handset in the front slot.

1. Slide the Spare Battery Pack into the second slot in the Charging Unit until the retaining clip snaps over the top of the pack.
2. Make sure the BATT CHARGE indicator lights. If the BATT CHARGE indicator does not light, check to see that the AC Adapter is plugged in, and that the Battery Pack makes good contact with the Charging Unit charging contacts.

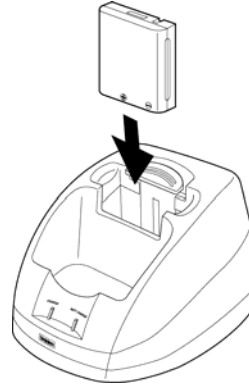

**Note:** Charge the Battery Pack without interruption for 12 to 15 hours.

3. When charging is complete, press out on the latch and remove the Battery Pack for use. If you do not need the Battery Pack immediately, leave it in the Charging Compartment; it will not overcharge.

## Low Battery Indicator

---

When the Battery Pack in the Handset is low and needs to be charged, you will see a message on the display.

On a Call	In Standby Mode
All keys and functions are available.	The buttons do not operate
Handset beeps once every 3 seconds.	Handset beeps every 15 seconds for 3 minutes.
Complete your call as quickly as possible.	Cannot make or receive a call.
Replace Battery pack within 20 seconds to continue call.	Replace Battery Pack before making a call.

Return the Handset to the Charging Unit for charging or replace the Handset Battery Pack with another charged Battery Pack.

## Cleaning the Battery and Charging Unit Contacts

---

To maintain a good charge, it is important to clean all charging contacts on the Handset, Spare Battery Pack and Charging Unit about once a month. Use a pencil eraser or a soft dry cloth. Do not use any liquids or solvents.

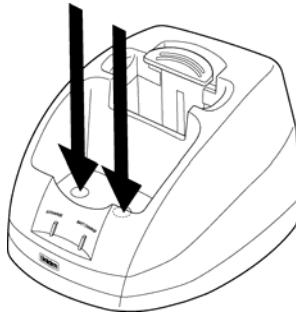

## Using Your DCKT970 Handset

Before using your DCKT970, be sure to raise the base unit antenna to the vertical position.

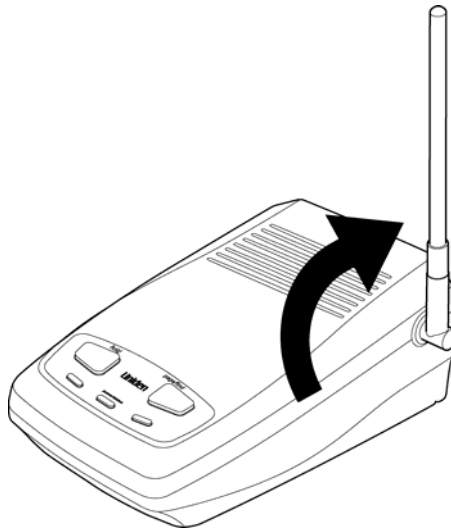

## DCKT970 Handset Controls

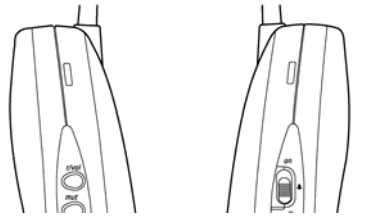

### Handset Display

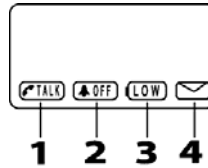

1. Cordless Phone is In Use
2. Cordless Phone is Off
3. Low Battery
4. Message Waiting

### Earpiece Volume

Press **R/VOL** on the side of the Handset during a call to change the earpiece volume on the handset.

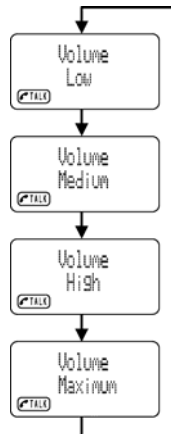

## Handset Ringer Tone and Volume

Press **R/VOL** on the side of the Handset in Standby mode to select seven ringer tones and volume combinations.



### Vibrate Mode

“Ring off” shown on the above display is the Vibrate Mode.

If you set the ringer off and the Handset is not on the charger, the Handset will vibrate when there is an incoming call.

If you set the ringer off and the Handset is on the charger, the Handset will ring as Ring Type-A Low.

## Handset Ringer Switch

The switch on the left side of the Handset turns the handset ringer ON or OFF.

When the switch on the side of the Handset is turned off, you will see the ring off icon.



When the switch on the side of the Handset is turned on, the ring off icon will disappear.

## Using the Handset

When you pick up the Handset and press **Talk**, you will see:



After the connection has been made between the Handset and Base, you will see:

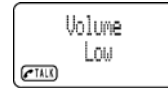

Or, you may see one of the following:

Condition	Indicator	LCD Screen
No Connection to Base Unit	Error Tone	NO SERVICE
Line in Use	Error Tone	LINE IN USE
If the Handset is at the range limit of the DCKT970 or no power is going to the Base Unit, you may see:		NO SERVICE

## Answering a Call

When you receive a call, the Handset rings and you will see:

A rectangular display showing the text "Incoming Call" in two lines.

Handset In the Charging Unit	Handset Out of Charging Unit
Pick up the Handset. The AutoTalk feature allows you to answer the call immediately	Press <i>Talk</i>
When you finish the call, place the Handset back in the Charging Unit. AutoStandby automatically hangs up the phone. —OR— Press <i>Talk</i> to hang up the phone	

## Making a Call

Press *Talk*. The *Talk* icon will illuminate after the Handset/Base are connected and you will see:

A rectangular display showing "Volume Low" in two lines. In the bottom left corner, there is a small icon of a handset with a speech bubble, labeled "TALK".

When you hear a dial tone, enter the number you are calling.

A rectangular display showing the phone number "8005351840" in two lines. In the bottom left corner, there is a small icon of a handset with a speech bubble, labeled "TALK".

When you finish the call, press the *Talk* button again, this will hang up the phone and put it in AutoStandby.

## Switching the Call on the Desk Telephone to the DCKT970

---

1. From the Desk telephone, place the call on **Hold**.



2. Press **Cordless** on the Base Unit.

The call is now transferred to the DCKT970 Digital Wireless Key Telephone, and the Desk phone is disconnected.

## Switching a Call from the DCKT970 to the Desk Telephone

---

1. From the DCKT970 Digital Wireless Key Telephone, place the call on **Hold**.
2. Press **Talk**.
3. Press **Desk** on the Base Unit. The Desk LED lights.
4. Place the DCKT970 back in the base unit.
5. Pick up the Desk Telephone handset and press the flashing line key to retrieve the call from hold.
6. Hang-up the Desk Telephone to terminate the call.

## Making a Call

---

1. Remove the Handset from the Base Unit.
2. Press *Talk*.
3. Do one of the following:

<b>If you are making an:</b>	<b>Then:</b>
outside call	Press a floating outside line group key (F1-F4) or dial a trunk access code. Wait for outside dial tone then dial the desired telephone number.
intercom call	Dial the desired extension number.
4. When you finish the call, place the Handset back on the Base Unit to terminate the connection,  
or,  
If the Handset is away from the Base Unit, press *Talk* to terminate the call.



## Feature Operation

*Note:* The exact operation of the Feature Buttons depends on how your ADIX APS or ADIX-VS system is configured. Contact your ADIX Administrator for more information.

### Placing a Call “On Hold”

---

1. Press **Hold**, then **Talk**.
2. To resume the call, **Talk**, then the line on Hold.

### Transferring a Call

---

1. Press **Tran**.
2. Dial the extension of the party where you are transferring the call.
3. When the receiving party answers, press **Talk** to complete the transfer.



## Feature Access Codes

The tables below list ADIX system features that are accessible from the DCKT900 by pressing FEAT plus a feature access code. For more information on the features listed below, refer to the ADIX Owner's Manual.

Feature	Access Code
Account Code Entry	[FEAT] + [2] [5]
Alter Tone/Pulse Dialing	[FEAT] + [1] [3]
Busy ICM Callback	[FEAT] + [4] [3] [FEAT] + [0] [4] [3] to cancel
Busy Number Callback	[FEAT] + [2] [4] [FEAT] + [0] [2] [4] to cancel
Busy Outside Line Queuing	[FEAT] + [2] [3] [FEAT] + [0] [2] [3] to cancel
Call Pickup - Direct	[FEAT] + [3] [3]
Call Pickup - External Group	[FEAT] + [3] [2]
Call Pickup - Internal Group	[FEAT] + [3] [1]
Extension Number Display	[FEAT] + [9] [9]
Feature Button Display	[FEAT] + [#] + [9] + {button}
Flash	[FEAT] + [1] [1]
Meet-Me Page Answer	[FEAT] + [3] [5]
Memo Dial	[FEAT] + [2] [2] to register, then, [FEAT] + [2] to call
Paging (All Call, Zone, Group)	ICM + {access code} *
Privacy/Privacy Release	[FEAT] + [1] [4]
Save Number Redial	[FEAT] + [2] [1]
Short Flash	[FEAT] + [1] [2]
Station Restriction Password	[FEAT] + [4] [4] [FEAT] + [0] [4] [4]
Time Reminder	[FEAT] + [4] [1]
UNA	[FEAT] + [3] [6]

## Optional (EXP9530) Headset

### EXP9530 Headset

---

The optional Headset provides a “Hands-Free” Option for the DCKT970. With the Headset installed, you can use the Beltclip to carry the Handset, and conduct a conversation using the Headset.

#### Installing the EXP9530

To install the optional Headset, open the cover over the Headset Jack and plug the Headset in.

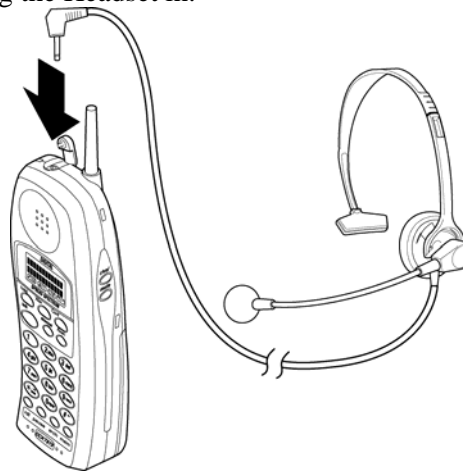





No other settings are needed.

Operation of the DCKT970 Digital Wireless Key Telephone using the Headset is exactly the same as using the Handset. However, you will hear through the Headset earphone and talk through the Headset microphone. The Handset earphone and microphone (mouthpiece) are disconnected.

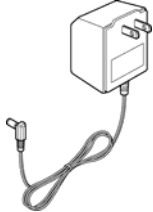
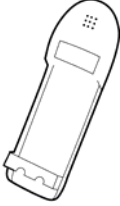

# Optional Accessories and Replacement Parts

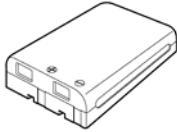
For the following Optional Accessories and Replacement Parts contact your System Administrator.

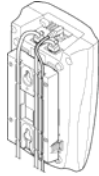
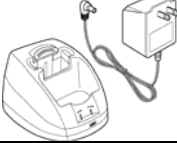
		
<p>EXP9704 AC Adaptor For Base Unit Part Number: 109514</p>	<p>EXP9783 Leather Case Part Number: 109519</p>	<p>EXP9702 Replacement Belt Clip Part Number: 109511</p>
		
<p>Sanyo Model BT2499 or GPI Model BT2499A Battery Part Number: 109515</p>	<p>DCKT970 Owner's Manual Part Number: 109530</p>	<p>EXP9660 Optional Wall Mount Plate Part Number: 109518</p>
		
<p>AD970 AC Adaptor for the Charger EXP9785 Charger Part Number: 109513 (AC Adaptor) Part Number: 109512 (Charger)</p>		



# Troubleshooting

If your DCKT970 Digital Wireless Key Telephone is not performing to your expectations, please try these simple steps. If you are still unable to resolve the problem, contact your System Administrator or Authorized Iwatsu Distributor.

*Note: Do not attempt to service this unit yourself. All service must be done by qualified service personnel.*

<b>Problem</b>	<b>Suggestion</b>
Charge light will not come on when the Handset is placed Charging Unit.	<ul style="list-style-type: none"><li>▪ Make sure the AC Adapter is plugged into the Charging Unit and wall outlet.</li><li>▪ Make sure Handset is properly seated in Charging Unit.</li><li>▪ Make sure the Battery Pack is properly placed in the Handset.</li><li>▪ Make sure that the charging contacts on the Handset and Charging Unit are clean.</li></ul>
Conversation interrupted frequently.	<ul style="list-style-type: none"><li>▪ Make sure that the Base Unit antenna is fully vertical.</li><li>▪ Move closer to the Base Unit.</li></ul>
Warning tone and NO SERVICE message.	<ul style="list-style-type: none"><li>▪ Move closer to the Base Unit.</li></ul>

Handset does not ring.

- The Battery Pack may be weak.  
Charge the Battery Pack for 5-6 hours.
- Make sure the Base Unit antenna is fully vertical.
- The Handset may be too far away from the Base Unit.
- Ensure the Ringer ON/OFF switch is in the ON Position.

# Specifications

<b>General:</b>	The DCKT970 complies with FCC and IC parts 15 and 68.
Frequency Control	Phase Lock Loop
Modulation	Spread Spectrum
Operating Temperature	0° to 50° C (+32° F to +122° F)
<b>Base Unit:</b>	
Receive/Transmit Frequency	902 MHz to 928 MHz
Power Requirements	10V DC from supplied AC Adapter
Size	4 1/4 in. W x 7 1/2 in. D x 2 1/4 in. H
Weight	Approx. 15.4 oz.
<b>Handset:</b>	
Receive/Transmit Frequency	902 MHz to 928 MHz
Power Requirements	Nickel-Cadmium Battery Pack
Size	2 1/5 in. W x 1 2/3 in. D x 8 2/3 in. H with antenna
Weight	Approx. 8.8 oz. with battery
Battery	Capacity 800 mAh, 3.6 V
Talk Time	6 hours (typical)
Standby Time	4 days (typical)
Specifications shown are typical and subject to change without notice.	



Iwatsu Voice Networks  
8001 Jetstar Drive Irving, TX 75063 972.929.0242  
[www.iwatsuvoicenetworks.com](http://www.iwatsuvoicenetworks.com)

Printed in USA

Part Number: 109530